

1

2

3

4

版本号	修订日期	修订记录
-----	------	------

V1.0.0.0	2022-11-22	输入电压最高支持24V。 添加内置驱动无刷电机接口、SPI-WIFI接口。
V1.0.1.0	2022-12-03	修改无线模块-串口、无线模块-SPI丝印。 增加ToF模块接口。
V1.1.0.0	2023-12-26	增加定位模块接口。



版权所有，保留一切权利。
本公司致力于产品的不断改善和功能升级，内容如有改动，恕不另行通知。

在此文件中，仅以版本号前两位(发行版)，划分版本之间的区别。

Title: TC264_0车模主板

Subtitle: Revision

Size: A4

Date: 2024/1/5

Time: 10:26:49

Author: 踏飞

Revision: V1.1.0.0

Sheet: 1

of: 5



1

2

3

4

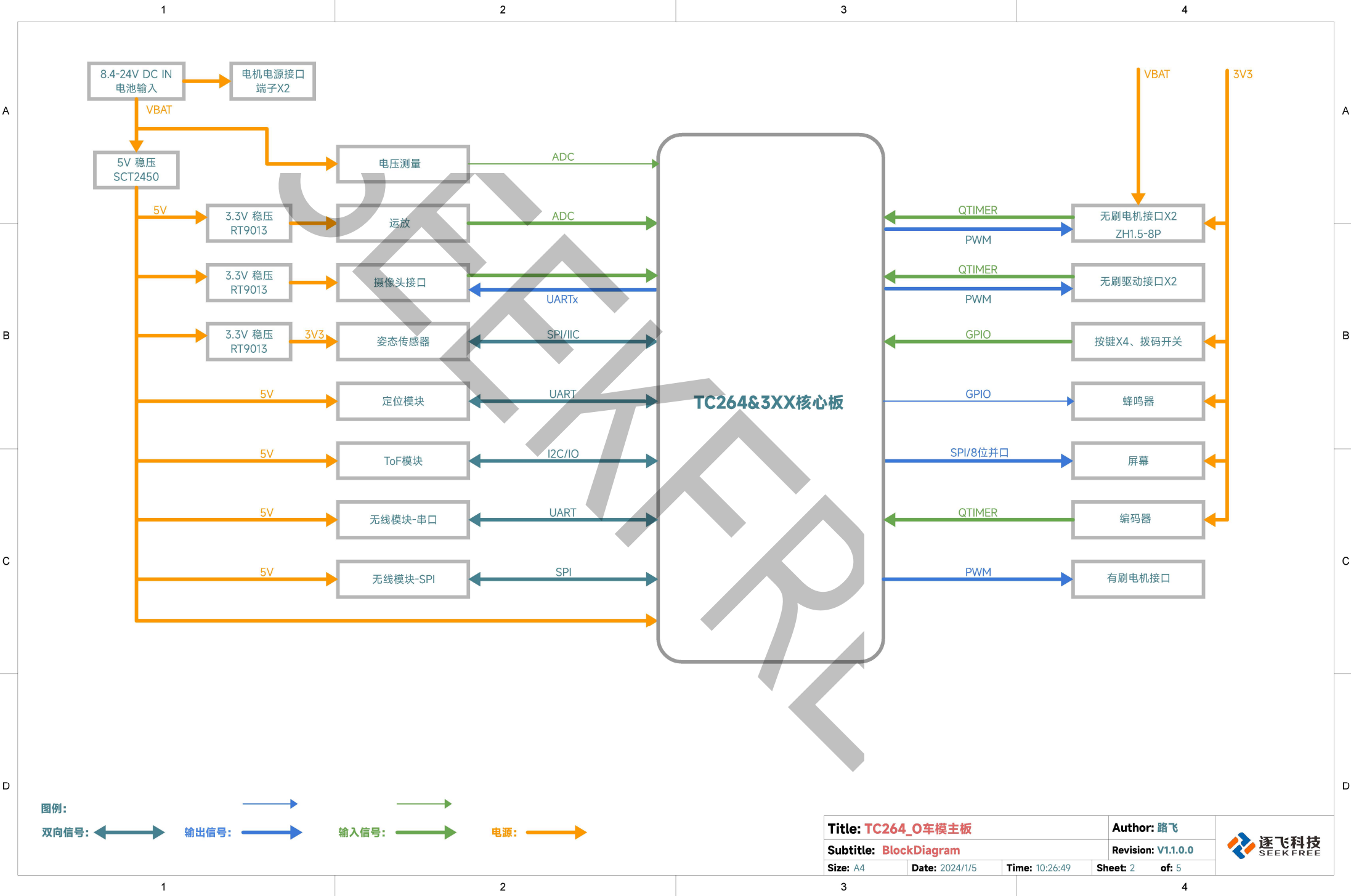

外设	功能	对应引脚
摄像头	PCLK	02.1
	VSY	02.0
	Tx	02.2
	Rx	02.3
	D0-D7	00.0-00.7
编码器	A	02.8
	B	00.9
运放	ADC	A0
	ADC	A1
	ADC	A2
	ADC	A3
屏幕接口	SCK	15.3
	MOSI	15.5
	RST	15.1
	DC	15.0
	CS	15.2
	BLK	15.4
	D0-D3	11.9-12
D4-D7	13.0-3	
电机	PWM	21.2
	PWM	21.3
	PWM	21.4
	PWM	21.5
拨码开关	IO	33.12
	IO	33.13
按键	IO	20.6
	IO	20.7
	IO	20.8
	IO	20.9
ToF接口	SCL	33.4
	SDA	33.5
	IO	20.10
	IO	33.8
蜂鸣器	IO	33.10
定位模块	Tx	15.6
	Rx	15.7

外设	功能	对应引脚
姿态传感器	SCK	20.11
	MOSI	20.14
	MISO	20.12
	CS	20.13
无线模块串口	Tx	10.5
	Rx	10.6
	RTS	10.2
	RST	11.6
无线模块SPI	SCK	22.3
	MOSI	22.0
	MISO	22.1
	CS	22.2
	RST	23.1
	INT	15.8
无刷驱动	A	33.7
	B	33.6
	DIR	02.4
	PWM	02.5
无刷电机	A	10.3
	B	10.1
	DIR	02.6
	PWM	02.7
无刷电机	IO	11.2
	PWM	02.5
	DIR	02.4
	A	33.7
	B	33.6
	IO	11.3
	PWM	02.7
DIR	02.6	
A	10.3	
B	10.1	
电池电压	ADC	A8

引脚表

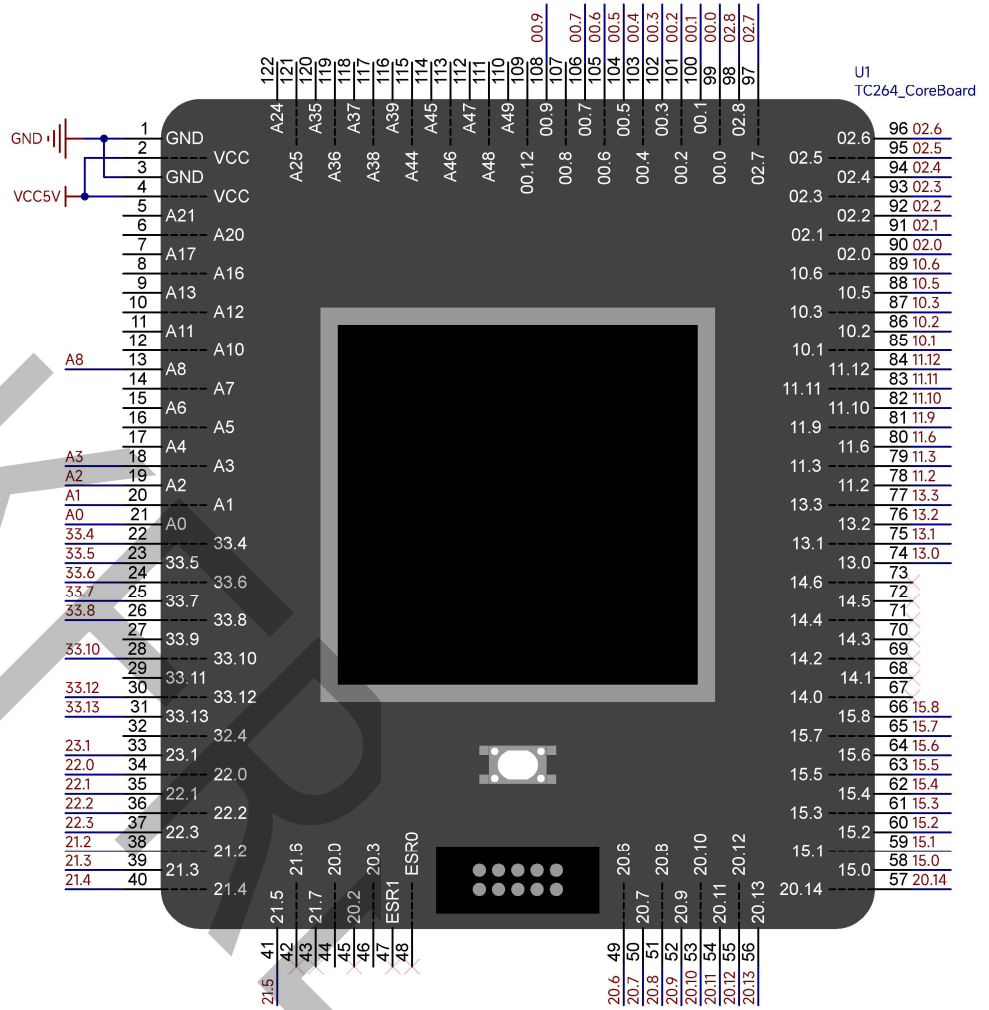

电源接口/开关

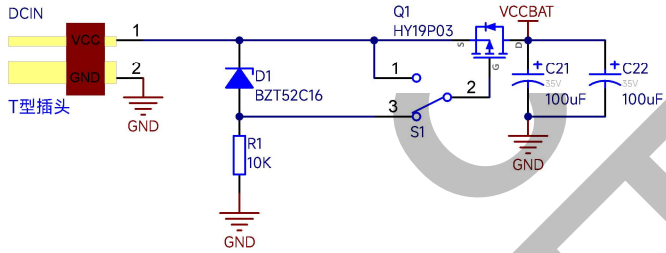

此电路为解决开关打火损耗而设计，可以用普通开关代替

电机电源接口

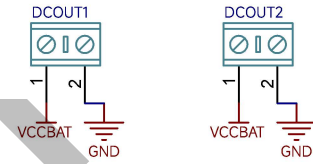

3V3电源

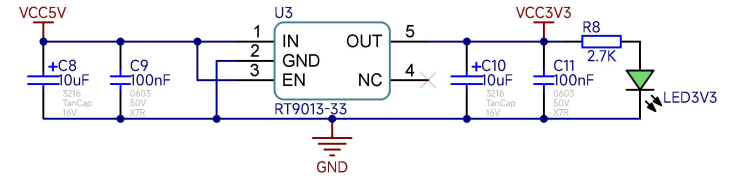

5V电源

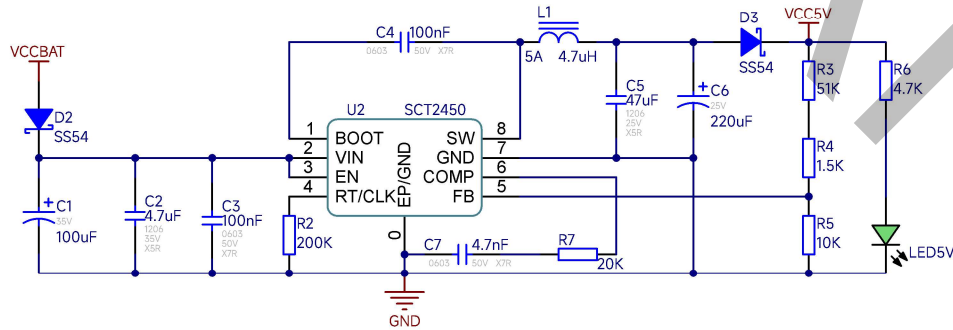

摄像头电源

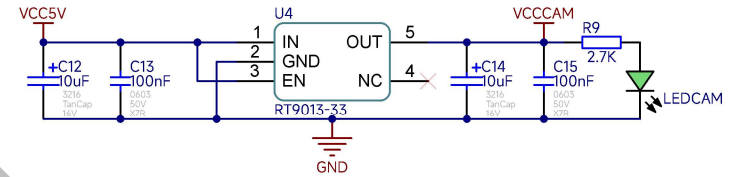

运放电源

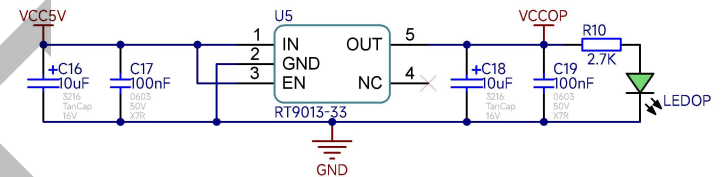

Title: TC264_O车模主板

Author: 路飞

Subtitle: PWR

Revision: V1.1.0.0

Size: A4

Date: 2024/1/5

Time: 10:26:50

Sheet: 4

of: 5



摄像头接口

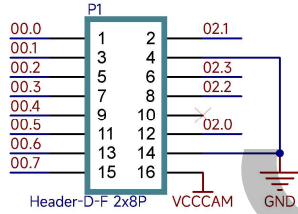

屏幕接口

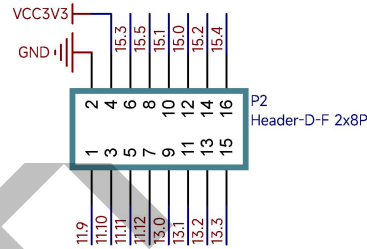

无刷电机1

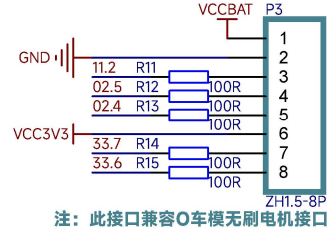

注：此接口兼容O车模无刷电机接口

无刷电机2

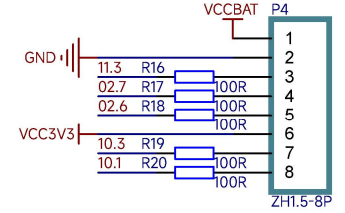

电磁运放模块接口

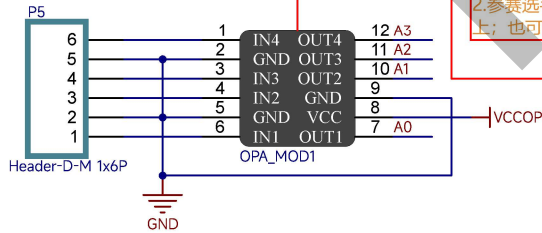

1.电磁运放模块是逐飞科技OPA4377运放模块插座，在PCB上对应器件为两个1x6P直插排座。并不是运放芯片！
2.参赛选手自己画原理图时，可以将运放模块电路集成在主板上；也可以自行制作运放模块，只在主板上放模块接口。

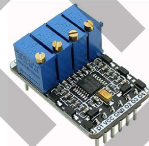

无刷驱动接口1

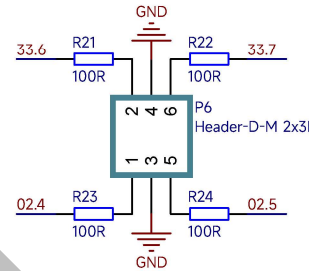

无刷驱动接口2

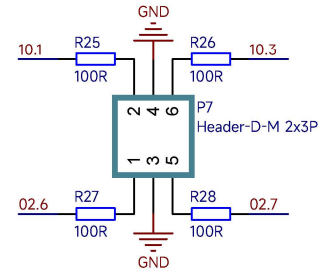

姿态传感器

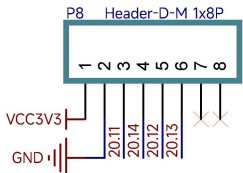

定位模块接口

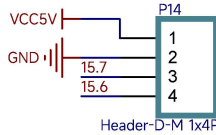

电压测量

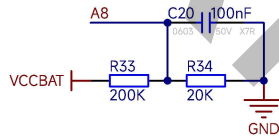

编码器接口

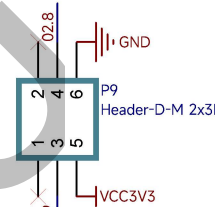

电机接口

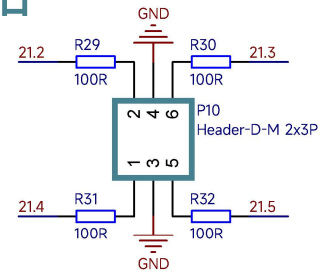

蜂鸣器

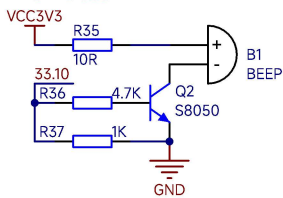

ToF接口

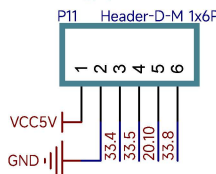

按键&拨码开关

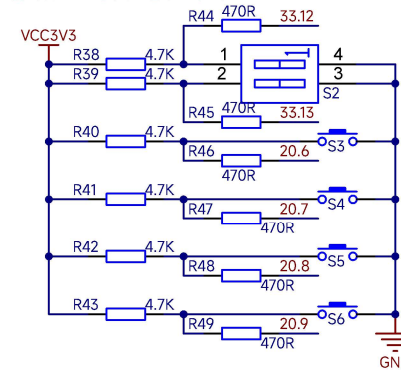

无线模块-串口

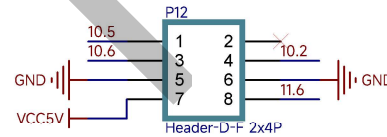

无线模块-SPI

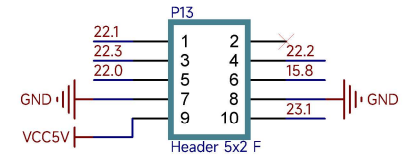

固定孔

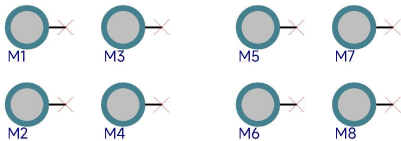

Title: TC264_O车模主板

Subtitle: Device

Size: A4

Date: 2024/1/5

Time: 10:26:50

Author: 踏飞

Revision: V1.1.0.0

Sheet: 5

of: 5

